

# Antistatic catalogue page 292

## Guarantee



## Product description

### Mechanism

- A-synchro mechanism, lockable in multiple positions;
- Seat height adjustable through 130 mm by means of a self-supporting gas lift mechanism which meets the DIN 4550/4551 standards;
- Backrest height is adjustable manually through 70 mm by means of a handwheel.

### Base

- 5 star base in "polished" aluminium (chrome effect),  $\varnothing$  680 mm;
- High chair with integral footrest,  $\varnothing$  650 mm, on fixed polypropylene glides with galvanised shaft, diameter 11 mm; chair on twin wheel

self-locking conductive castors,  $\varnothing$  50 mm, for use on hard floors - polyamide castors available as an optional extra.

### Padding



- Seat: CFC-free polyurethane foam, glued to the support frame, density 30 kg/m<sup>3</sup>, 45 mm in thickness;
- Backrest: CFC-free polyurethane foam, glued to the support frame, density 30 kg/m<sup>3</sup>, 30 mm in thickness.

### Covering

- Fabric, glued to the foam padding and stapled to the support frame;
- 1 special antistatic fabric colour available from stock black TH.

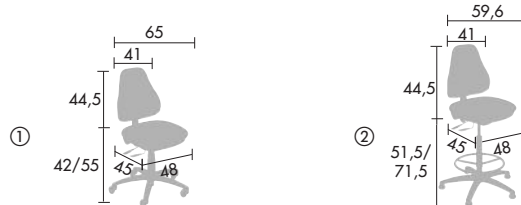
## The Range



|  | description           | code            | price ex. VAT |
|--|-----------------------|-----------------|---------------|
|   | ① Chair               | 5 314 012 TH SQ | £ 344         |
|  | ② Draughtsman's chair | 5 314 009 TH SQ | £ 361         |

# Polyurethane catalogue page 292

## Guarantee



## Product description

3 polyurethane models: de luxe high chair on glides, typists's chair on castors and sit-stand stool on glides.

### Mechanism

- Seat height adjustable by means of a class 4 self-supporting gas lift mechanism which meets the DIN 4550/4551 and NF 61041 standards - high chair adjustable through 260 mm, typists' chair adjustable through 130 mm and stool adjustable through 200 mm;
- Backrest height of high chair and typist's chair adjustable through 80 mm (from 340 to 420 mm) by means of a lever;
- Seat depth adjustable through 50 mm (from 410 to 460 mm) by means of a lever.

### Base



- 5 star base in fibreglass reinforced polyamide black (nylon),  $\varnothing$  630 mm;
- Footrest,  $\varnothing$  455 mm, made from chrome-plated tubular steel,  $\varnothing$  15 mm, 1.5 mm in thickness, attached by rivets to a 4 point support structure made from injection-moulded aluminium coated in black epoxy paint.

### Padding

- CFC-free polyurethane black foam injected on to the support frame (average thickness on seat: 25 mm, average thickness on backrest: 22 mm).

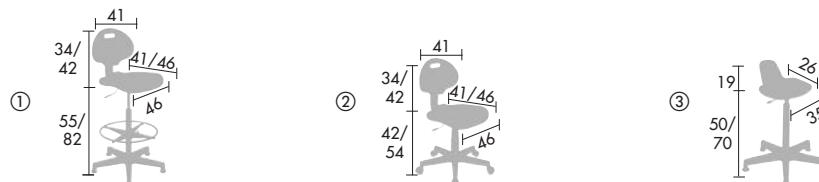
## The Range



|   | description                 | code            | price ex. VAT |
|---|-----------------------------|-----------------|---------------|
|  | ① Draughtsman's chair       | 5 678 003 PA SV | £ 149         |
|  | ② Typists's chair           | 5 678 004 PA SV | £ 132         |
|  | ③ Sit-stand stool on glides | 5 678 005 PA SV | £ 123         |

# Draughtsman's chairs catalogue page 292

## Guarantee and shade card

**5**  
YEAR  
GUARANTEE

4 choices of fabric colour



Celestial black FA    Electric blue FC    Royal bordeaux FE    Storm grey FG

From stock

## Product description

### Mechanism

- Permanent contact mechanism, lockable in any position, with adjustable tension control;
- Seat height adjustable through 120 mm (from 650 to 770 mm) by means of a gas lift mechanism;
- Backrest adjustable by means of a handwheel.

### Base

- 5 star base in black nylon (SV);
- Chrome-plated footrest, ø 46 cm.

### Padding

- Seat: polyether foam, density 31 kg/m<sup>3</sup>, 60 mm in thickness; Backrest: polyether foam, density 28 kg/m<sup>3</sup>, 40 mm in thickness.

### Covering

- Fabric, glued to the foam padding and stapled to the support frame;
- 4 choices of fabric colour available from stock.

## The Range

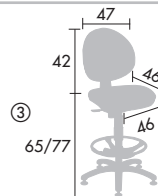
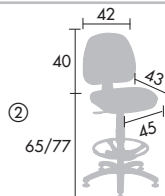
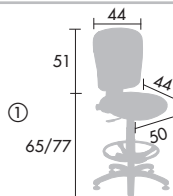

### description

### code

### price ex. VAT

① High back draughtsman's chair

5 509 001 + fab. + SV

£ 154

② Standard back draughtsman's chair

5 644 001 + fab. + SV

£ 179

③ Rounded back draughtsman's chair

5 508 001 + fab. + SV

£ 204

# High chairs and stools catalogue page 293

## Guarantee and shade card

**2**  
YEAR  
GUARANTEE

2 choices of finish



Natural beech WP    Black simulated leather YA

From stock

## Product description

4 models: high chairs (in simulated leather or beech plywood) and stools (in simulated leather or beech plywood).

### Mechanism

- Seat height adjustable by means of a gas lift mechanism.

### Base

- Chrome-plated 5 star base and fixed footrest, ø 44 cm, with non-slip glides.

### Padding

- Seat: foam, density 25 kg/m<sup>3</sup>, 35 mm in thickness;
- Backrest: foam, density 25 kg/m<sup>3</sup>, 30 mm in thickness.

### Covering

- Simulated leather upholstery or seat in 18 mm thick varnished beech.

## The Range

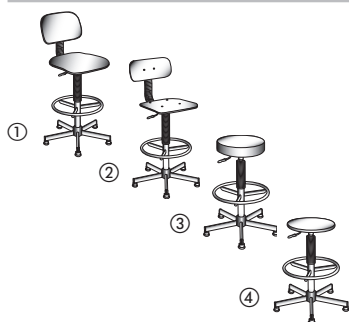
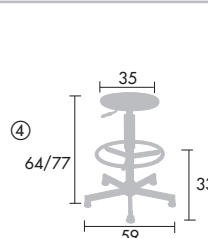
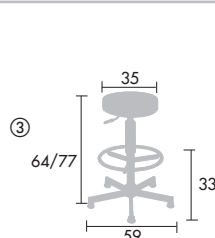
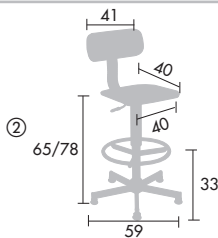
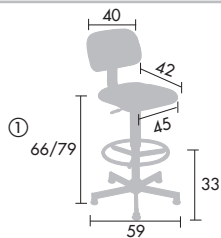

### description

### code

### price ex. VAT

① Simulated leather high chair

5 511 002 YA

£ 120

② Wood high chair

5 511 002 WP

£ 124

③ Simulated leather stool

5 511 001 YA

£ 115

④ Wood stool

5 511 001 WP

£ 95

# Ergoform catalogue page 293

## Guarantee



## Product description

### Mechanism

- Seat height adjustable through 130 mm (from 520 to 650 mm) by means of a gas lift mechanism.

### Base

- 5 star base in reinforced nylon.

### Padding

- Seat and backrest: polyether foam, density 30 kg/m<sup>3</sup>, 50 mm in thickness.

### Covering

- 1 colour - black - available from stock.

## The Range

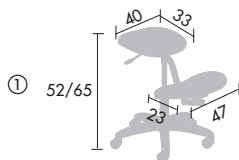

|   | description      | code            | price ex. VAT |
|---|------------------|-----------------|---------------|
|  | ① Ergoform chair | 5 676 002 FA SV | £ 159         |

# Allday catalogue page 293

## Guarantee and shade card



| 2 choices of fabric colour |             | 2 choices of fabric colour |                 |
|----------------------------|-------------|----------------------------|-----------------|
|                            |             |                            |                 |
| Night blue<br>UC           | Black<br>UD | Bordeaux<br>UE             | Dark grey<br>UF |
| From stock                 |             | On request                 |                 |

## Product description

2 models: standard back chair with adjustable arms and high back chair with fixed arms.

### Mechanism

- Synchro mechanism, suitable for intensive, round-the-clock use, lockable in multiple positions with backrest reverse lock system;
- Seat height adjustable by means of a gas lift mechanism; seat translation on the standard back chair;
- Backrest height adjustable by means of a ratchet mechanism.

### Base

- Injection-moulded 5 star base;
- Reinforced twin wheel castors.

### Padding

- Seat: polyurethane foam, density 51.3 kg/m<sup>3</sup>, 90 to 130 mm in thickness; Backrest: polyurethane foam, density 54.5 kg/m<sup>3</sup>, 90 to 130 mm in thickness.

### Covering



- 2 choices of fabric colour available from stock (fabrics are specially designed to withstand intensive round-the-clock use).

### Arms

- Standard back chair: height and width-adjustable polyurethane arms;
- High back chair: fixed polyurethane arms covered in protective film.

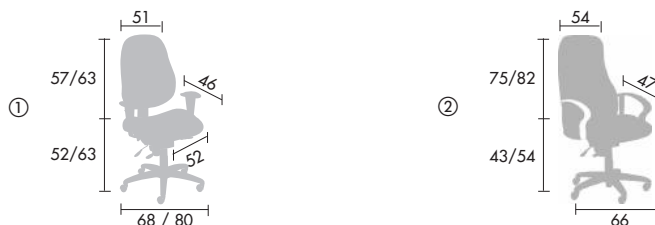
## The Range



|   | description                            | code                  | price ex. VAT |
|---|--|-----------------------|---------------|
|   | ① Executive chair with adjustable arms | 5 677 004 + fab. + SV | £ 988         |
|  | ② Executive chair with fixed arms      | 5 677 001 + fab. + SV | £ 1 403       |

# Teamer catalogue page 294

## Guarantee, standards, shade card and mechanisms



5 choices of fabric colour

|                            |                       |                 |                     |                   |
|----------------------------|-----------------------|-----------------|---------------------|-------------------|
|                            |                       |                 |                     |                   |
| Black fire-resistant<br>DO | Celestial black<br>FA | Dark blue<br>FB | Graphite grey<br>FU | Bright blue<br>FW |

From stock

43 COLOURS

On request - allow 4 weeks for delivery. See p. 346-347

2 choices of finish for base

|                   |                  |
|-------------------|------------------|
|                   |                  |
| Black nylon<br>SV | Grey nylon<br>SZ |

From stock From stock

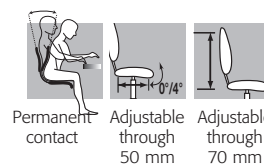

## The Range

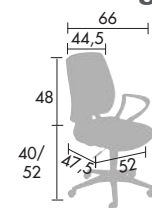

## Product description

### Mechanism

- Medium back permanent contact mechanism, lockable in any position. Seat height is adjusted by means of an ergonomically designed handle located at the bottom of the shaft linking the seat to the backrest;
- Seat height manually adjustable through 120 mm by means of a gas lift mechanism;
- Backrest height adjustable through 70 mm by means of an "up and down" ratchet system (notch by notch adjustment with automatic return to the lowest position when the maximum height has been reached).

### Base

- 5 star base in black or grey polyamide (fibreglass reinforced nylon) with steel reinforcement in the cone,  $\varnothing$  660 mm;
- Twin wheel self-locking black polyamide castors,  $\varnothing$  50 mm;
- 2 choices of finish: black nylon (SV) from stock or grey nylon (SZ) on request.

- Seat: CFC-free polyurethane foam, glued to the support frame, density 40 kg/m<sup>3</sup>, 47 mm in thickness; Backrest: CFC-free polyurethane foam, glued to the support frame, density 28 kg/m<sup>3</sup>, 35 mm in thickness.

### Covering

- Fabric, glued to the foam padding and stapled to the support frame;
- 5 choices of fabric colour available from stock.

### Arms

- Fixed closed arms in black or grey injection moulded polypropylene. Attached to the seat using screws and easy to remove;
- Height-adjustable arms in black or grey nylon. Adjustable through 70 mm. Mounting plates in black lacquered steel.

| Padding | description  | code   | price ex. VAT  |                |
|---------|--|--|----------------|----------------|
|         |  |  | Fabric A       | Fabric B       |
|         | ① Without arms<br>Black shell and base<br>Grey shell and base                            | 5 669 005 + fab. + SV<br>5 669 005 + fab. + SZ | £ 173<br>£ 190 | £ 190<br>£ 207 |
|         | ② With fixed arms<br>Black shell, base and arms<br>Grey shell, base and arms             | 5 669 002 + fab. + SV<br>5 669 002 + fab. + SZ | £ 210<br>£ 227 | £ 227<br>£ 243 |
|         | ③ With height-adjustable arms<br>Black shell, base and arms<br>Grey shell, base and arms | 5 669 006 + fab. + SV<br>5 669 006 + fab. + SZ | £ 220<br>£ 237 | £ 237<br>£ 253 |

# Motiv' catalogue page 294

## Guarantee, standards, shade card and mechanisms



2 choices of fabric

|             |            |
|-------------|------------|
|             |            |
| Black<br>DO | Blue<br>DR |

From stock

46 COLOURS

On request - allow 4 weeks for delivery. See p. 346-347

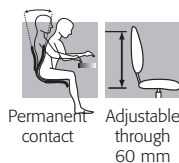

## The Range

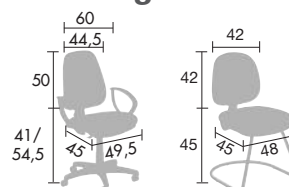

## Product description

### Mechanism

- Medium back permanent contact mechanism, lockable in any position. Seat height adjustable through 130 mm by means of a self-supporting gas lift mechanism;
- Backrest height is adjustable manually through 60 mm by means of a handwheel;

### Base

- 5 star base in polyamide black (fibreglass reinforced nylon),  $\varnothing$  640 mm;
- Twin wheel self-locking ABS castors,  $\varnothing$  50 mm, with polypropylene covers and galvanised shafts, diameter 11 mm.

### Padding

- Seat: CFC-free polyurethane foam, glued to the support frame, density 40 kg/m<sup>3</sup>, 45 mm in thickness; Backrest: CFC-free polyurethane foam, glued to the support frame, density 30 kg/m<sup>3</sup>, 40 mm in thickness.

### Covering

- Fabric, glued to the foam padding and stapled to the support frame;
- 2 choices of M1 flame retardant fabric colour available from stock.

### Arms

- Fixed or height-adjustable arms in polypropylene. Adjustable to 6 positions. Mounting plates in steel.

| description | code   | price ex. VAT |          |
|-------------|--|---------------|----------|
|             |  | Fabric A      | Fabric B |
|             | ① Without arms<br>5 309 014 + fab. + SV                | £ 140         | £ 157    |
|             | ② With fixed arms<br>5 309 012 + fab. + SV             | £ 177         | £ 193    |
|             | ③ With height-adjustable arms<br>5 309 013 + fab. + SV | £ 196         | £ 212    |
|             | ④ Without arms<br>5 309 017 + fab.                     | £ 135         | £ 152    |
|             | ⑤ With fixed arms<br>5 309 018 + fab.                  | £ 172         | £ 186    |

**Guarantee, standards, shade card and mechanisms**



10 choices of fabric colour  
 Celestial black FA, Dark blue FB, Dark grey with light grey spots FK, Light grey FQ, Grey FR, Black FS, Graphite grey FU, Bordeaux FV, Bright blue FW, Red FX  
 From stock



On request - allow 4 weeks for delivery. See p. 346-347

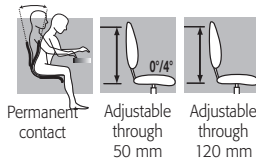

**The Range**

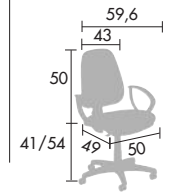

**Product description**

**Mechanism**

- High back permanent contact mechanism, lockable in any position. Seat height adjustable through 130 mm by means of a self-supporting gas lift mechanism;
- Backrest height is adjustable manually through 120 mm by means of a knurled handwheel located on the shaft linking the seat to the backrest.

**Base**

- 5 star base in fibreglass reinforced polyamide (nylon) black, ø 600 mm;
- Twin wheel self-locking ABS castors, ø 50 mm, with polypropylene covers and galvanised shafts, diameter 11 mm.

**Padding**

- Seat and backrest: CFC-free polyurethane foam, glued to the support frame, density 25 kg/m<sup>3</sup> at the centre and 30 kg/m<sup>3</sup> at the sides, 40 mm in thickness at the centre and on secondary reinforcement braces, 20 mm in thickness at the sides.

**Covering**

- Fabric, glued to the foam padding and stapled to the support frame;
- 10 choices of fabric colour available from stock.

**Arms**

- Fixed closed arms in black injection moulded polypropylene with steel mounting plates;
- Height-adjustable arms in black nylon. Adjustable through 70 mm. Mounting plates in black lacquered steel;
- Arms are attached to the seat using screws and easy to remove.

|  | description                   | code                  | price ex. VAT |          |
|--|-------------------------------|-----------------------|---------------|----------|
|  |                               |                       | Fabric A      | Fabric B |
|  | ① Without arms                | 5 307 009 + fab. + SV | £ 128         | £ 144    |
|  | ② With fixed arms             | 5 307 010 + fab. + SV | £ 161         | £ 178    |
|  | ③ With height-adjustable arms | 5 307 011 + fab. + SV | £ 178         | £ 194    |

**Guarantee, standards and shade card**



2 choices of fabric colour



Electric blue UA, Black UB  
 From stock

**The Range**

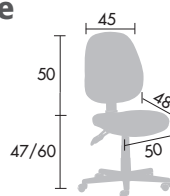

**Product description**

**Mechanism**

- Medium back a-synchro mechanism, lockable in multiple positions;
- Seat height manually adjustable through 130 mm by means of a gas lift mechanism;
- Backrest height is adjustable manually by means of a handwheel.

**Base**

- 5 star base in black polyamide (nylon);
- Twin wheel castors.

**Padding**

- Backrest: CMHR polyether foam, density 30 kg/m<sup>3</sup>, 50 mm in thickness;
- Seat: CMHR polyether foam, density 35 kg/m<sup>3</sup>, 70 mm in thickness.

**Covering**

- British Standard Festivo fabric upholstery - meets standards BS EN 1021-1-2006 and BS EN 1021-2-2006;
- 2 choices of fabric colour available from stock.

**Arms**

- Fixed closed arms in injection moulded polypropylene.

|  | description    | code                  | price ex. VAT |          |
|--|----------------|-----------------------|---------------|----------|
|  |                |                       | Fabric A      | Fabric B |
|  | ① Without arms | 5 642 002 + fab. + SV | £ 109         |          |
|  | ② With arms    | 5 642 003 + fab. + SV | £ 134         |          |