

Catalogue pages 188 to 199

Guarantee, standards and shade card



2 choices of finish for wood veneer tops



Wenge-stained oak
WD
Honey walnut
WZ
From stock

2 choices of finish for enamelled glass tops



Brilliant light grey
GB
Brilliant black
GD
From stock

2 choices of finish for wood veneer tubular and panel legs



Wenge-stained oak
WD
Honey walnut
WZ
From stock

1 finish for tubular metal legs



Aluminium
SA
Sur stock

2 finish for melamine cupboard shells



Aluminium grey
MH
Graphite grey
MY
From stock

3 choices of finish for side panels of supporting returns



Brilliant beige
LE
Wenge-stained oak
WD
Honey walnut
WZ
From stock

Product description

- Made from MDF, density 830 kg/m³, and particle board, density 660 kg/m³;
- Wood used is sourced from sustainably managed forest;
- The board is overlaid with a sheet of wood veneer, 7/10 thickness, and then stained using an environmentally friendly water-based colouring agent and covered in 3 coats of polyurethane varnish (desktops) or 4 coats of UV varnish (legs, doors and pedestals);
- 2 choices of wood veneer finish: wenge-stained oak (WD) or honey walnut (WE);
- The varnish has a semi-matt finish;
- Particle board used is compliant with the E1 standard (control of formaldehyde emissions).

Prestige wood veneer tops

- 30 mm thick, with inverted "gull wing" edges, and boasting on the visitors's side of the desk a sheet of inlaid glass in a brilliant light grey lacquered finish;

Wood veneer tops

- 17 mm thick, made from MDF, with straight edges covered in a wood veneer, 15/10 thickness;
- Tops are attached to the structure.

Glass tops

- Made from Securit toughened glass, screen printed on the underside and shiny on the top surface;
- 10 mm thick;
- Edges have polished flat seams;

Panel legs

- Panel legs made from MDF covered with a sheet of wood veneer over a metal sub-frame;
- 70 mm thick;
- Welded metal plates are attached to the top of the legs;
- Stabilizer feet, adjustable through 15 mm.

Square legs - wood veneer finish

- Tubular legs made from MDF covered with a sheet of wood veneer over a metal sub-frame;
- cross-section 70 x 70 mm;
- Welded metal plates are attached to the top of the legs;
- Stabilizer feet, adjustable through 15 mm.

Square legs - metal finish

- Epoxy coated tubular metal legs in an aluminium grey finish, cross-section 70 x 70 mm;
- Legs and support structure are securely attached by means of screws.

Structure:

- Tubular metal support structure, cross-section 50 x 50 mm;
- Aluminium grey epoxy finish;
- Legs and support structure are securely attached by means of screws.

Cupboards, tower units and credenzas

- Melamine shells and shelves in an aluminium grey (MH) or graphite grey (MY) finish;
- Doors, decorative tops and optional side panels covered in a wood veneer to match the desks;
- High cupboards are fitted with a fixed shelf. Other shelves are adjustable at 32 mm intervals;
- Doors are fitted with metal handles in an aluminium finish;
- High cupboards have 3 point locks, medium and low cupboards have 1 point locks. Glass doors are not lockable;
- Glass doors are made from Securit toughened glass, 4 mm in thickness, in a brilliant light grey or brilliant black enamelled finish, and are fitted with aluminium frames;
- When fitted with optional metal shelves, high cupboards will hold 5 rows of suspension files;
- 4 stabilizer feet, H. 35 mm, adjustable through 15 mm;
- Width 80 cm. Depth 40.7 cm.

Supporting return

- Made from 19 mm thick particle board, density 670 kg/m³, covered in high pressure laminate in a brilliant beige finish;
- Comprising 2 swing door cupboards with "push & up" opening mechanism and a central CPU compartment;
- Fitted with decorative tops and side panels in a laminate or wood veneer finish and mounted on adjustable stabilizer feet.

Cable management

- Horizontal: in the form of optional cable brackets for attachment to the underside of the desktop;
- Vertical: in the form of optional PVC cable holders for attachment to the legs using adhesive or ABS vertebral cable holders for attachment to the underside of the desktop.

Maintenance

- Wipe in the direction of the grain using a soft damp cloth. Being a natural product, wood veneers may appear to vary in colouring and pattern, particularly when viewed at different angles to the grain and at different angles to the light.

Desktops and easy reach storage units - the range

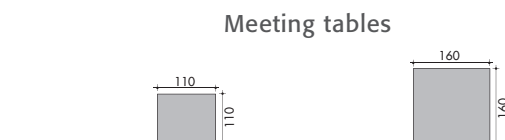
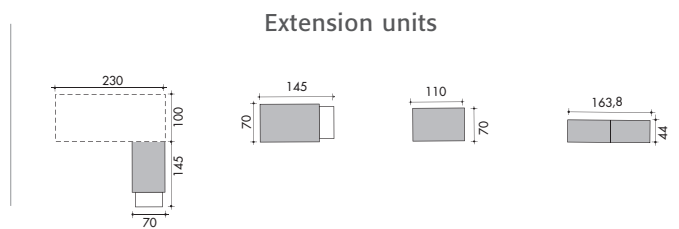
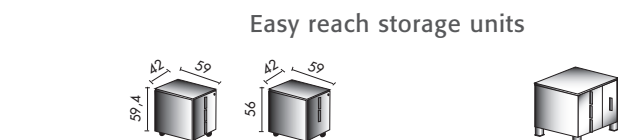
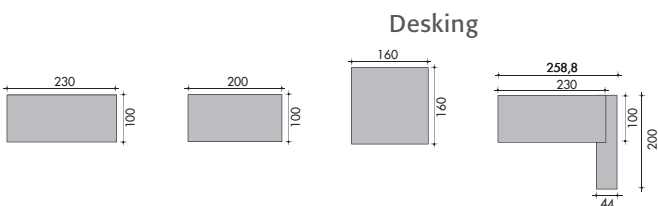

Deco storage units, cupboards, credenzas and tower units - the range

Deco storage units

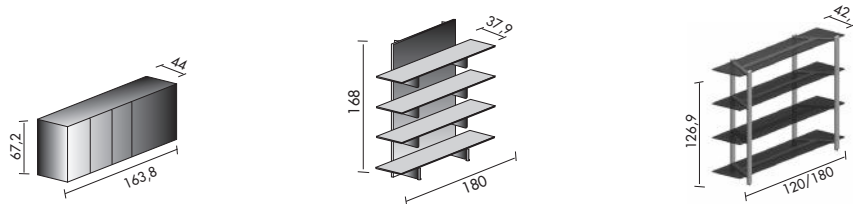

Credenzas

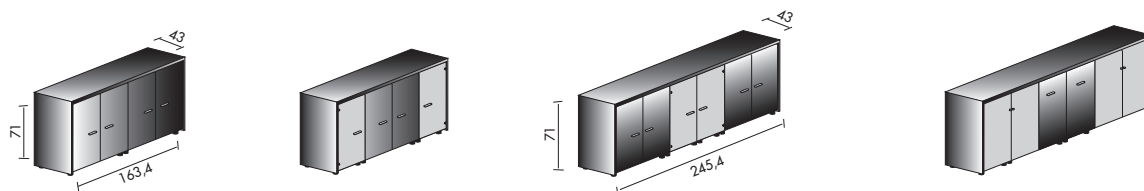



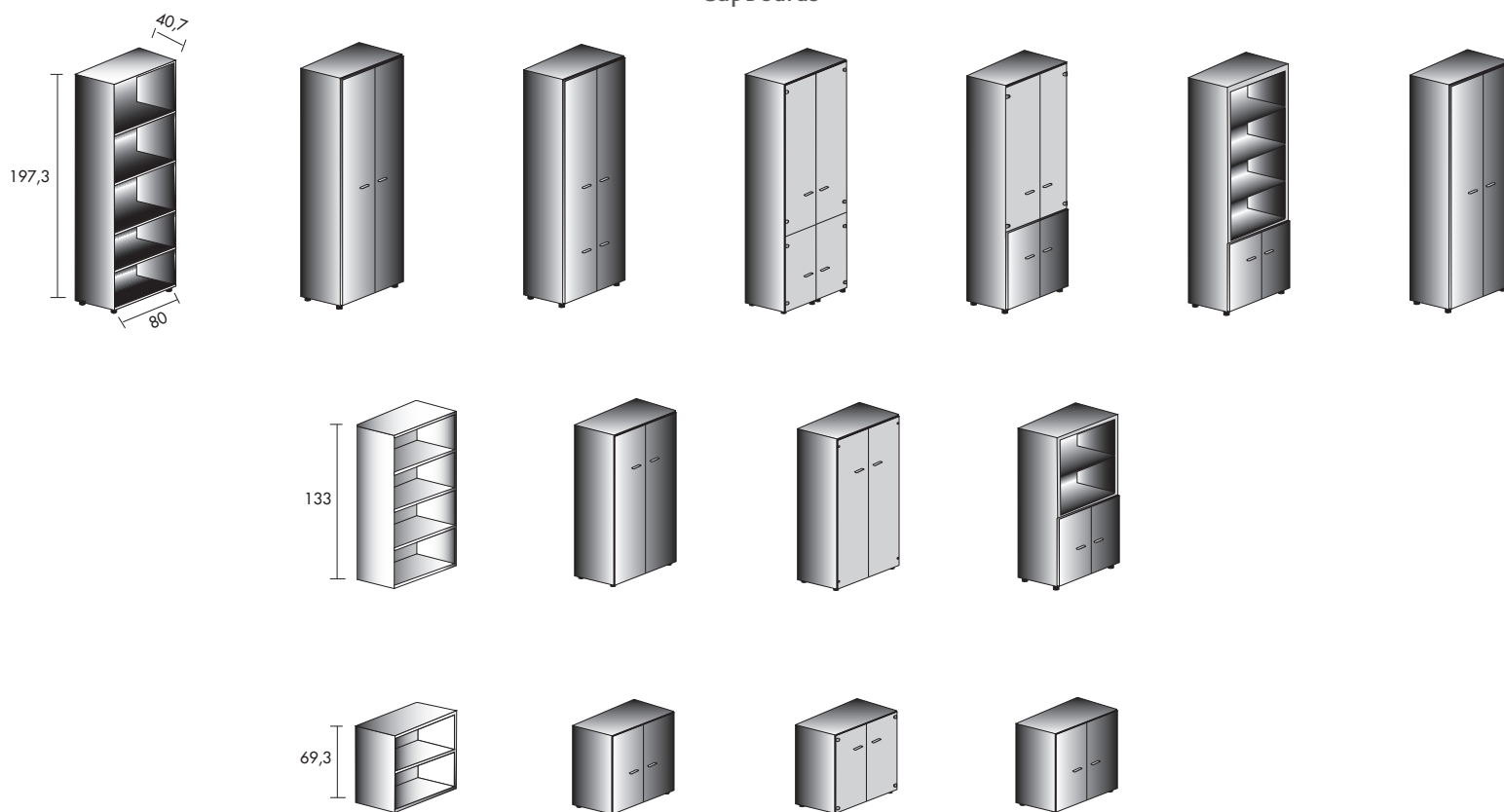



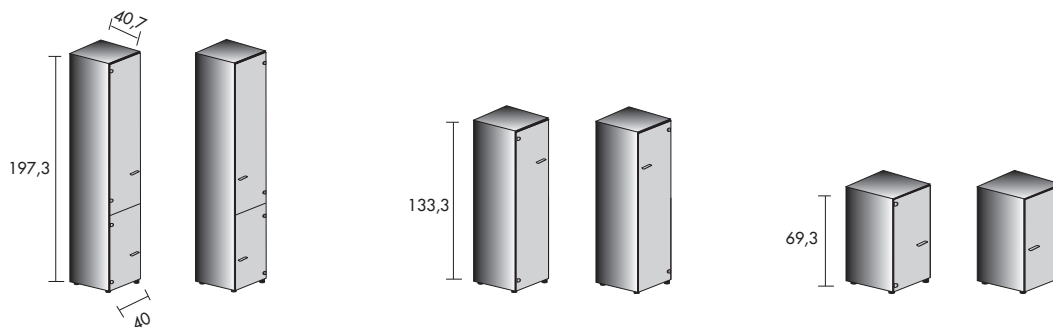

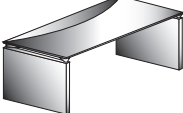
Cupboards

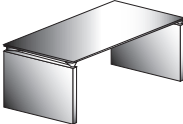
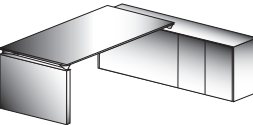
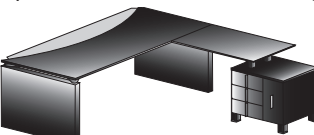
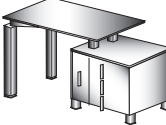

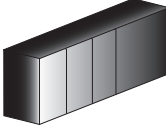
Tower units

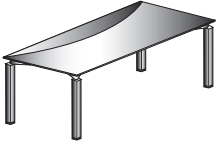
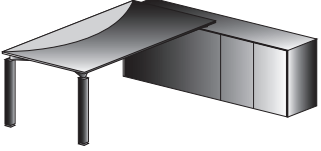
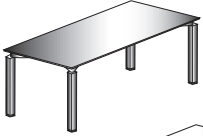
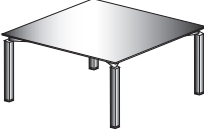
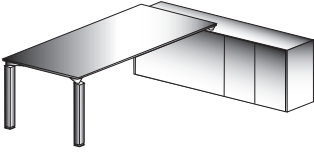
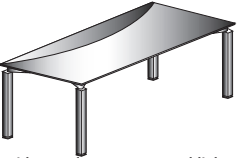
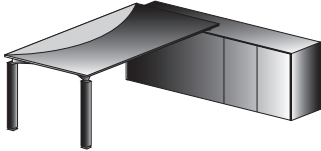
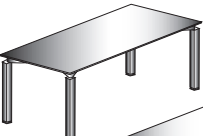

| description | code | price ex. VAT | |
|---|--|--|-----------|
| | | Wood veneer top | Glass top |
| Noveum - Panel legs | | | |
| Desking - Prestige | | | |
| Desks with wood veneer top and light grey lacquered glass inlay | | | |
|  | W. 230 x 100 cm | 3 375 156 + desktop fin. + leg fin. | £ 2 241 |
| Desks with wood veneer top and light grey lacquered glass inlay plus supporting return with beige laminate doors and beige laminate or wood veneer top and side panels. | | | |
|  | W. 259 x 200 cm with wood veneer top and side panels | 3 375 158 + desktop fin. + leg fin. + return top/panels fin. | £ 3 486 |
| | W. 259 x 200 cm with beige laminate top and side panels | 3 375 158 + desktop fin. + leg fin. + LE | £ 3 071 |
| Desking - Wood veneer or Diamond | | | |
| Desks with wood veneer or glass top | | | |
|  | W. 230 x D. 100 cm | 3 375 256 + desktop fin. + leg fin. | £ 1 868 |
| | W. 200 x D. 100 cm | 3 375 252 + desktop fin. + leg fin. | £ 1 735 |
| Desks with wood veneer or glass top plus supporting return with beige laminate doors and beige laminate or wood veneer top and side panels. | | | |
|  | W. 259 x D. 200 cm with wood veneer top and side panels | 3 375 154 + desktop fin. + leg fin. + return top/panels fin. | £ 3 113 |
| | W. 259 x D. 200 cm with beige laminate top and side panels | 3 375 154 + desktop fin. + leg fin. + LE | £ 2 698 |
| | W. 239 x D. 200 cm with wood veneer top and side panels | 3 375 152 + desktop fin. + leg fin. + return top/panels fin. | £ 2 980 |
| | W. 239 x D. 200 cm with beige laminate top and side panels | 3 375 152 + desktop fin. + leg fin. + LE | £ 2 565 |
| Extension units | | | |
| Suspended return with wood veneer or glass top plus 3 drawer metal pedestal, complete with built-in CPU compartment, in aluminium grey with wood veneer top and drawer fronts. | | | |
|  | W. 145 x D. 70 cm. | 3 375 237 + desktop fin. + leg fin. | £ 1 785 |
| Free-standing return with wood veneer or glass top plus 3 drawer pedestal complete with built-in CPU compartment. | | | |
|  | W.145 x D. 70 cm wood veneer leg | 3 375 235 + desktop fin. + leg fin. | £ 1 785 |
| | W.145 x D. 70 cm square metal leg | 3 375 235 + desktop fin. + leg fin. | £ 2 117 |
| Free-standing return with wood veneer or glass top and legs of square section in a wood veneer or metal finish. | | | |
|  | W. 110 x D. 70 cm wood veneer leg | 3 375 236 + desktop fin. + leg fin. | £ 1 536 |
| | W.110 x D. 70 cm square metal leg | 3 375 236 + desktop fin. + leg fin. | £ 1 162 |
| Free-standing return unit with swing doors. Laminate shell and doors in a brilliant beige finish. "Push & up" opening mechanism. Beige laminate or wood veneer top and side panels. | | | |
|  | W. 163.8 x D. 44 x H. 67.2 cm | | |
| | Wood veneer top and side panels | 3 375 185 LE + top/panels fin. | £ 1 370 |
| | Beige laminate top and side panels | 3 375 185 LE LE | £ 822 |
| Easy reach storage units | | | |
| Wood veneer pedestals - 2 drawer models are weighted to prevent them from tipping over. Drawers are mounted on telescopic runners. Central locking mechanism. Metal handles in aluminium grey. Drawer interiors are made from solid beech coated in varnish. W. 42 x D. 59 x H. 59.4 cm (on request) | | | |
|  | 1 box drawer + 1 filing drawer | 3 375 140 + finish + SA | £ 1 453 |
| | 3 box drawers | 3 375 142 + finish + SA | £ 1 453 |
| | Optional pen tray in solid beech | 3 375 284 XV | £ 173 |
| Metal mobile pedestals in an aluminium grey finish with wood veneer tops and drawer fronts. Metal drawers. Drawers are mounted on telescopic runners with ball-bearing rollers and open to a depth of 100%. Concealed runners. Selective drawer opening. Built-in pen tray. Central locking mechanism. Folding key. | | | |
|  | 1 box drawer + 1 filing drawer | 3 375 146 + finish + SA | £ 743 |
| | 3 box drawers | 3 375 148 + finish + SA | £ 743 |
| | Extra-wide model with 3 box drawers + CPU compartment | 3 375 149 + finish + SA | £ 1 591 |

| description | | code | price ex. VAT | |
|--|--|--|---------------|---------|
| Noveum - Square legs in a wood veneer finish | | | | |
| Desking - Prestige | | | | |
| Desks with wood veneer top and light grey lacquered glass inlay and legs of square section in a wood veneer finish. | | | | |
|  | W. 230 x D. 100 cm | 3 375 155 + desktop fin. + leg fin. | £ 2 158 | |
| Desks with wood veneer top and light grey lacquered glass inlay and legs of square section in a wood veneer finish plus supporting return with beige laminate doors and beige laminate or wood veneer top and side panels. | | | | |
|  | W. 259 x D. 200 cm with wood veneer top and side panels | 3 375 157 + desktop fin. + leg fin. + return top/panels fin. | £ 3 403 | |
| | W. 259 x D. 200 cm with beige laminate top and side panels | 3 375 157 + desktop fin. + leg fin. + LE | £ 2 988 | |
| Desking - Wood veneer or Diamond | | | | |
| Desks with wood veneer or glass top and legs of square section in a wood veneer finish. | | | | |
|  | W. 230 x D. 100 cm | 3 375 255 + desktop fin. + leg fin. | £ 1 785 | £ 2 034 |
|  | W. 200 x D. 100 cm | 3 375 251 + desktop fin. + leg fin. | £ 1 652 | £ 1 901 |
| | W. 160 x D. 160 cm | 3 375 249 + desktop fin. + leg fin. | £ 1 785 | £ 2 067 |
| Desks with wood veneer or glass top and legs of square section in a wood veneer finish plus supporting return with beige laminate doors and beige laminate or wood veneer top and side panels. | | | | |
|  | W. 259 x D. 200 cm with wood veneer top and side panels | 3 375 153 + desktop fin. + leg fin. + return top/panels fin. | £ 3 030 | £ 3 279 |
| | W. 259 x D. 200 cm with beige laminate top and side panels | 3 375 153 + desktop fin. + leg fin. + LE | £ 2 615 | £ 2 864 |
| | W. 239 x D. 200 cm with wood veneer top and side panels | 3 375 151 + desktop fin. + leg fin. + return top/panels fin. | £ 2 897 | £ 3 030 |
| | W. 239 x D. 200 cm with beige laminate top and side panels | 3 375 151 + desktop fin. + leg fin. + LE | £ 2 482 | £ 2 615 |
| Noveum - Square legs in an aluminium grey metal finish | | | | |
| Desking - Prestige | | | | |
| Desks with wood veneer top and light grey lacquered glass inlay and legs of square section in a metal finish. | | | | |
|  | W. 230 x D. 100 cm | 3 375 155 + desktop fin. + SA | £ 1 909 | |
| Desks with wood veneer top and light grey lacquered glass inlay and legs of square section in a metal finish plus supporting return with beige laminate doors and beige laminate or wood veneer top and side panels. | | | | |
|  | W. 259 x D. 200 cm with wood veneer top and side panels | 3 375 157 + desktop fin. + SA + return top/panels fin. | £ 3 237 | |
| | W. 259 x D. 200 cm with beige laminate top and side panels | 3 375 157 + desktop fin. + SA LE | £ 2 698 | |
| Desking - Wood veneer or Diamond | | | | |
| Desks with wood veneer or glass top and legs of square section in a metal finish. | | | | |
|  | W. 230 x D. 100 cm | 3 375 255 + desktop fin. + SA | £ 1 494 | £ 1 785 |
|  | W. 200 x D. 100 cm | 3 375 251 + desktop fin. + SA | £ 1 370 | £ 1 652 |
| | W. 160 x D. 160 cm | 3 375 249 + desktop fin. + SA | £ 1 486 | £ 1 681 |

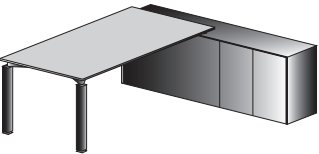
| description | code | price ex. VAT | | |
|---|--|--|-----------|---------|
| | | Wood veneer top | Glass top | |
| Desks with wood veneer or glass top plus supporting return with beige laminate doors and beige laminate or wood veneer top and side panels. | | | | |
|  | W. 259 x D. 200 cm with wood veneer top and side panels | 3 375 153 + desktop fin. + SA + return top/panels fin. | £ 2 864 | £ 3 113 |
| | W. 259 x D. 200 cm with beige laminate top and side panels | 3 375 153 + desktop fin. + SA + LE | £ 2 449 | £ 2 698 |
| | W. 239 x D. 200 cm with wood veneer top and side panels | 3 375 151 + desktop fin. + SA + return top/panels fin. | £ 2 814 | £ 2 864 |
| | W. 239 x D. 200 cm with beige laminate top and side panels | 3 375 151 + desktop fin. + SA + LE | £ 2 399 | £ 2 449 |

Extension units

Suspended return with wood veneer or glass top plus 3 drawer pedestal, complete with built-in CPU compartment.

| | | | | |
|---|-------------------|-------------------------------------|---------|---------|
|  | W. 145 x D. 70 cm | 3 375 237 + desktop fin. + leg fin. | £ 1 785 | £ 1 826 |
|---|-------------------|-------------------------------------|---------|---------|

Free-standing return with wood veneer or glass top plus 3 drawer pedestal complete with built-in CPU compartment.

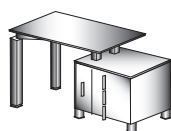

| | | | |
|--|-------------------------------------|---------|---------|
| W. 145 x D. 70 cm with square legs in a wood veneer finish | 3 375 235 + desktop fin. + leg fin. | £ 2 283 | £ 2 324 |
| W. 145 x D. 70 cm with square legs in a metal finish | 3 375 235 + desktop fin. + SA | £ 2 117 | £ 2 200 |

Free-standing return with wood veneer or glass top and legs of square section in a wood veneer or metal finish.



| | | | |
|--|-------------------------------------|---------|---------|
| W. 110 x D. 70 cm with square legs in a wood veneer finish | 3 375 236 + desktop fin. + leg fin. | £ 1 536 | £ 1 577 |
| W. 110 x D. 70 cm with square legs in a metal finish | 3 375 236 + desktop fin. + SA | £ 1 162 | £ 1 204 |

Free-standing return unit with swing doors. Laminate shell and doors in a brilliant beige finish. "Push & up" opening mechanism. Beige laminate or wood veneer top and side panels. W. 163.8 x D. 44.4 x H. 67.2 cm.

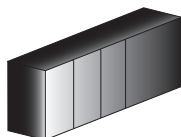

| | | |
|------------------------------------|----------------------------------|---------|
| Wood veneer top and side panels | 3 375 185 + LE + top/panels fin. | £ 1 370 |
| Beige laminate top and side panels | 3 375 185 + LELE | £ 822 |

Easy reach storage units

Wood veneer pedestals - 2 drawer models are weighted to prevent them from tipping over. Drawers are mounted on telescopic runners. Central locking mechanism. Metal handles in aluminium grey. Drawer interiors are made from solid beech coated in varnish. W. 42 x D. 59 x H. 59.4 cm (on request)



| | | |
|----------------------------------|-------------------------|---------|
| 1 box drawer + 1 filing drawer | 3 375 140 + finish + SA | £ 1 453 |
| 3 box drawers | 3 375 142 + finish + SA | £ 1 453 |
| Optional pen tray in solid beech | 3 375 284 XV | £ 173 |

Metal mobile pedestals in an aluminium grey finish with wood veneer tops and drawer fronts. Metal drawers. Drawers are mounted on telescopic runners with ball-bearing rollers and open to a depth of 100%. Concealed runners. Selective drawer opening. Built-in pen tray. Central locking mechanism. Folding key.



| | | |
|---|-------------------------|---------|
| 1 box drawer + 1 filing drawer | 3 375 146 + finish + SA | £ 743 |
| 3 box drawers | 3 375 148 + finish + SA | £ 743 |
| Extra-wide model with 3 box drawers + CPU compartment | 3 375 149 + finish + SA | £ 1 536 |

Meeting tables

Meeting tables with wood veneer or glass top and legs of square section in a wood veneer or metal finish.

For a more extensive choice of Noveum meeting tables, see page 102

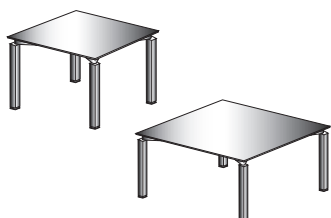

| | | | |
|---|---------------------------------|---------|---------|
| W. 110 x D. 110 cm with square legs in a wood veneer finish | 3 375 260 + top fin. + leg fin. | £ 1 515 | £ 1 536 |
| W. 110 x D. 110 cm with square legs in a metal finish | 3 375 260 + top fin. + SA | £ 1 204 | £ 1 224 |
| W. 160 x D. 160 cm with square legs in a wood veneer finish | 3 375 263 + top fin. + leg fin. | £ 1 785 | £ 2 067 |
| W. 160 x D. 160 cm with square legs in a metal finish | 3 375 263 + top fin. + SA | £ 1 486 | £ 1 681 |

| description | code | price ex. VAT |
|-------------|------|---------------|
|-------------|------|---------------|

Deco storage units

Deco credenzas

Credenza with laminate shell and doors in a beige finish. Swing doors with "push & up" opening mechanism. W. 163.4 x D. 44 x H. 67.2 cm.

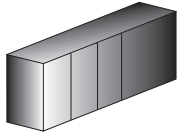

| | | |
|------------------------------------|--|---------|
| Wood veneer top and side panels | 3 375 185 + wood veneer top/panels fin. + LE | £ 1 370 |
| Beige laminate top and side panels | 3 375 185 LE LE | £ 822 |

4 and 6 door wood veneer credenzas. Comprising 2 or 3 modular cupboards, H. 69.3 cm, complete with decorative wood veneer top and side panels.



| | | |
|--|---|---------|
| W. 163.4 x D. 43 x H. 71 cm 4 wooden doors | 3 375 126 + door fin. + top/panels fin. | £ 1 324 |
| 2 wooden doors + 2 brilliant enamelled glass doors | 3 375 280 + wood veneer door fin. + top/panels fin. + glass door fin. | £ 1 619 |



| | | |
|---|---|---------|
| W. 243.4 x D. 43 x H. 71 cm 4 wooden doors + 2 brilliant enamelled glass doors | 3 375 282 + wood veneer door fin. + top/panels fin. + glass door fin. | £ 2 075 |
| 2 wooden doors + 4 brilliant enamelled glass doors | 3 375 281 + wood veneer door fin. + top/panels fin. + glass door fin. | £ 2 336 |

Prestige bookshelves

Wood veneer back with metal uprights. 4 brilliant enamelled glass shelves to match the desktops. The shelves are supported by metal brackets in aluminium grey.

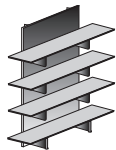

| | | |
|------------------------------|------------------------------------|---------|
| H. 168 x W. 180 x D. 37.9 cm | 3 375 103 + back fin. + shelf fin. | £ 1 785 |
|------------------------------|------------------------------------|---------|

Diamond bookshelves

Tubular metal uprights in aluminium grey. 8 mm thick Securit toughened glass shelves in a brilliant enamelled finish, H 126.9 x D. 42.1 cm.



| | | |
|-----------|-----------------------------|---------|
| W. 120 cm | 3 375 101 + shelf fin. + SA | £ 1 204 |
| W. 180 cm | 3 375 102 + shelf fin. + SA | £ 1 536 |

Cupboards







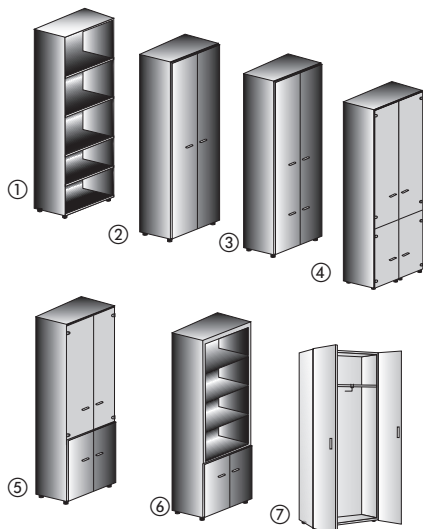



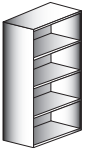



19 mm thick melamine shells in an aluminium grey finish. Wood veneer doors or 4 mm thick Securit toughened glass doors in an enamelled finish with aluminium frames.







Optional extras: ⑧ ⑨ ⑩ ⑪ ⑫.

Cupboards, H. 197.3 x W. 80 x D. 40.7 cm - 4 shelves

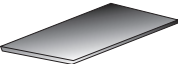
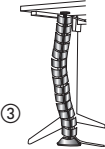

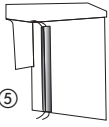
| | | |
|---------------------------------------|---|---------|
| ① Open shelves | 3 375 100 + shell fin. | £ 241 |
| ② 2 standard doors | 3 375 120 + door fin. + shell fin. | £ 872 |
| ③ 4 standard doors | 3 375 122 + door fin. + shell fin. | £ 1 025 |
| ④ 4 glass doors | 3 375 123 + door fin. + shell fin. | £ 1 619 |
| ⑤ 1/3 standard doors, 2/3 glass doors | 3 375 125 + wooden door fin. + shell fin. + glass door fin. | £ 1 320 |
| ⑥ 1/3 standard doors, 2/3 bookshelves | 3 375 124 + door fin. + shell fin. | £ 598 |
| ⑦ Wardrobe unit | 3 375 118 + door fin. + shell fin. | £ 872 |

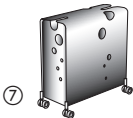
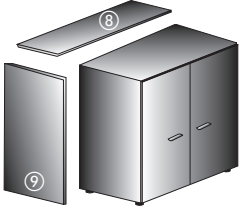
| description | code | price ex. VAT |
|---|---|--|
| Cupboards, H. 133.3 x W. 80 x D. 40.7 cm - 3 shelves | | |
| Optional extras: ⑧ ⑨ ⑩ ⑪ ⑫. | | |
|   | ⑧ Open shelves | 3 375 099 + shell fin. £ 203 |
|   | ⑨ 2 wooden doors | 3 375 113 + door fin. + shell fin. £ 593 |
| | ⑩ 2 enamelled glass doors | 3 375 114 + door fin. + shell fin. £ 988 |
| | ⑪ 2 wooden doors + open shelves | 3 375 117 + door fin. + shell fin. £ 515 |
| Cupboards, H. 69.3 x W. 80 x D. 40.7 cm - 1 shelf | | |
|   | ⑫ Open shelves | 3 375 098 + shell fin. £ 120 |
| | ⑬ 2 standard doors | 3 375 106 + door fin. + shell fin. £ 457 |
|   | ⑭ 2 enamelled glass doors | 3 375 107 + door fin. + shell fin. £ 706 |
| | ⑮ 2 standard doors with refrigerator unit | 3 375 333 + door fin. + shell fin. £ 1 029 |
| Tower units | | |
| Set of 2 tower units. 19 mm thick melamine shells. Doors and tops made from 4 mm thick Securit toughened glass in a black or light grey enamelled finish with aluminium frames. Optional extras: ⑥ ⑨ ⑩. | | |
| H. 197.3 x W. 40 x D. 40.7 cm - 4 shelves | | |
|   | Set of 2 tower units | ⑯ Enamelled glass doors with aluminium frames 3 375 094 + door fin. + shell fin. £ 1 743 |
| H. 133.3 x W. 40 x D. 40.7 cm - 3 shelves | | |
|   | Set of 2 tower units | ⑰ Enamelled glass doors with aluminium frames 3 375 096 + door fin. + shell fin. £ 1 079 |
| H. 69.3 x W. 40 x D. 40.7 cm - 1 shelf | | |
|   | Set of 2 tower units | ⑱ Enamelled glass doors with aluminium frames 3 375 095 + door fin. + shell fin. £ 789 |

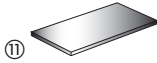
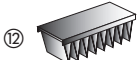
| description | code | price ex. VAT |
|--|--|--|
| Optional extras for desking | | |
| Modesty panels. In enamelled glass, H. 27 cm | | |
|  | ① For desks of width 200 cm For desks of width 230 cm | 3 375 183 £ 165 3 375 184 £ 195 |
| Leather desk mat. Black finish. | | |
|  | ② W x D cm: 90 x 45 | 3 375 204 YB £ 141 |
| Vertical cable management. In the form of a dual channel plastic vertebral cable holder. Aluminium (Oi) finish. Attachable to the desktop by clamp or using wood screws. H. 81.5 x ø 6.1 cm. | | |
|  | ③ Vertebral cable holder | 3 375 264 Oi £ 44 |
| Set of 2 cable brackets in black (OF) ABS. For attachment to the desktop using wood screws (supplied). | | |
|  | ④ Set of 2 cable brackets | 3 375 265 OF £ 12 |
| Multi-position cable holder | | |
|  | ⑤ Cable holder | 3 375 266 OF £ 14 |
| De luxe keyboard shelf. Metal in an aluminium grey (SA) finish. Adjustable in height from 7 to 10.5 cm. W. 57 x D. 30.5 cm. | | |
|  | ⑥ De luxe keyboard shelf | 3 375 267 SA £ 131 |
| Perforated mobile metal CPU pedestal in an aluminium grey (SA) finish. Adjustable in width from 8 to 25 cm. | | |
|  | ⑦ Designer CPU pedestal | 3 375 268 SA £ 178 |
| Optional extras for cupboards, credenzas and tower units | | |
| Decorative tops and side panels in a wood veneer finish to match the doors. 17 mm thick wood veneer decorative tops | | |
|  | ⑧ Width 80 cm Width 160 cm Width 240 cm | 3 375 269 + finish £ 165 3 375 270 + finish £ 248 3 375 271 + finish £ 324 |
| ⑨ 19 mm thick wood veneer side panels (set of 2) Height 69.3 cm Height 133.3 cm Height 197.3 cm | 3 375 272 + finish £ 212 3 375 273 + finish £ 311 3 375 274 + finish £ 374 | |
| Set of 2 rails for suspension files - for attachment to the underside of melamine shelves using wood screws. | | |
|  | ⑩ Set of 2 rails | 3 375 275 OF £ 22 |
| Additional melamine shelf | | |
|  | ⑪ Shelf | 3 375 276 + fin. £ 23 |
| Optional metal shelf for suspension files. 330 mm hanging centre lateral files. | | |
|  | ⑫ Metal shelf | 3 375 277 SC £ 23 |